

# vel. 38

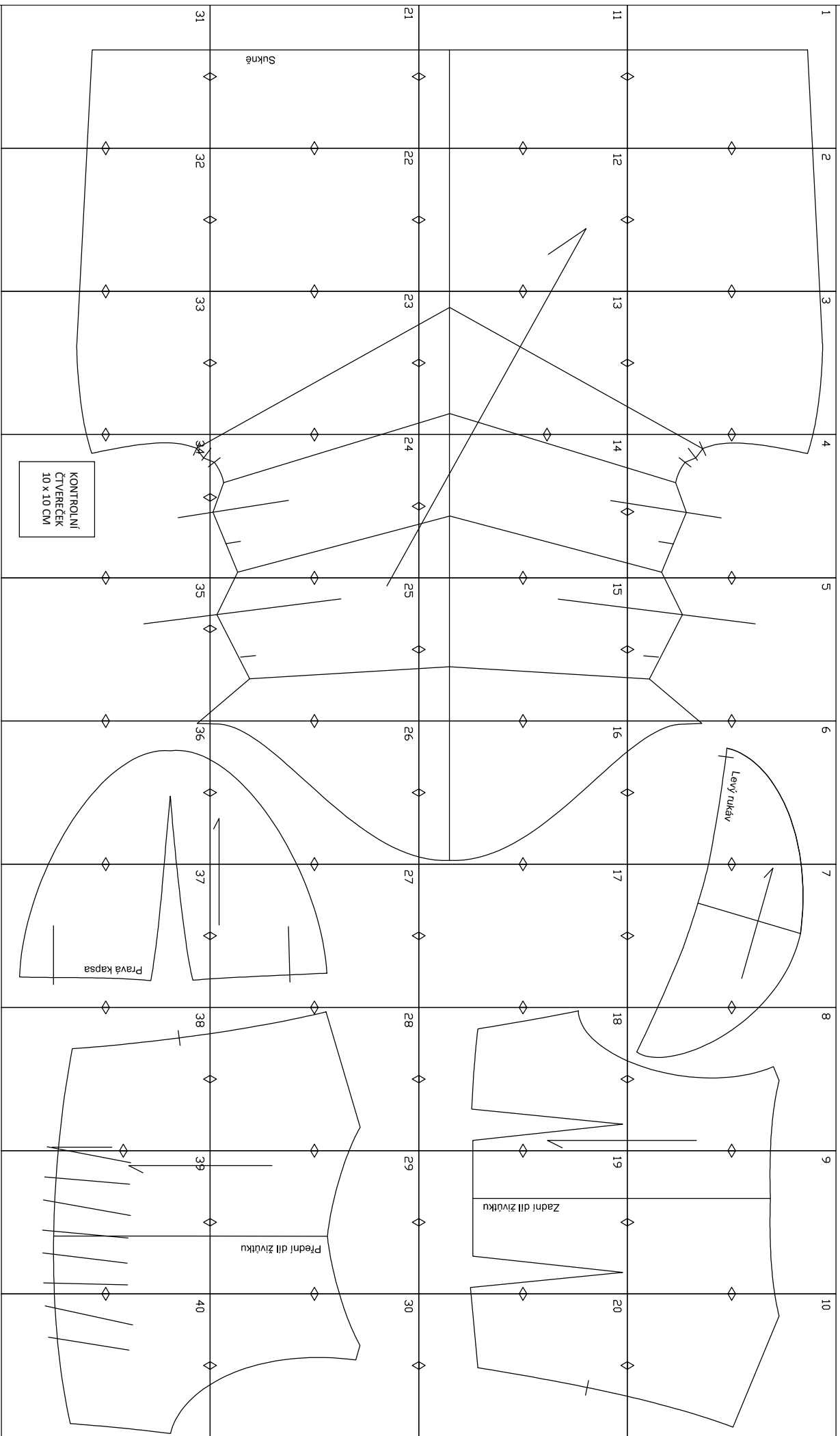

1



2



3

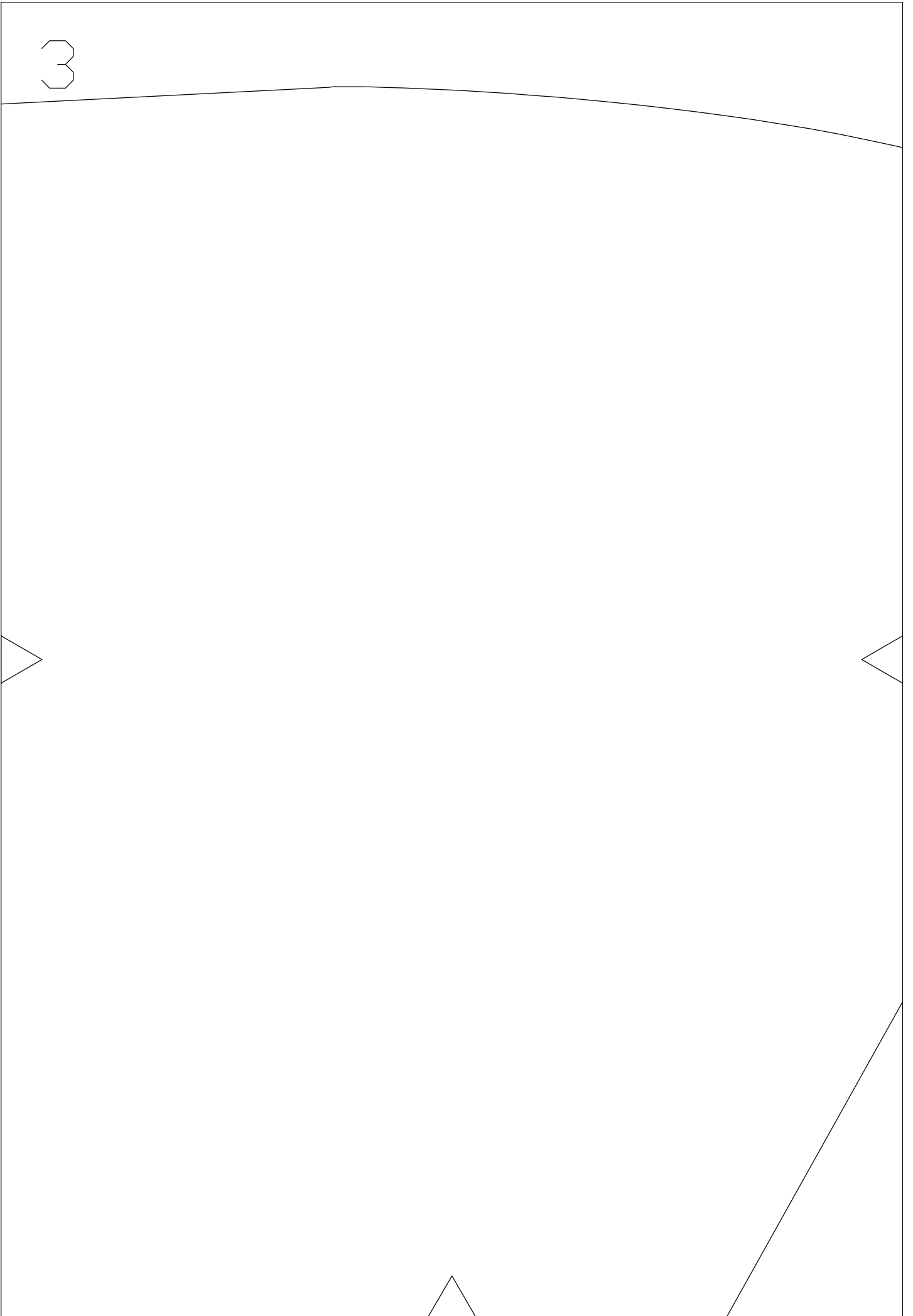

4

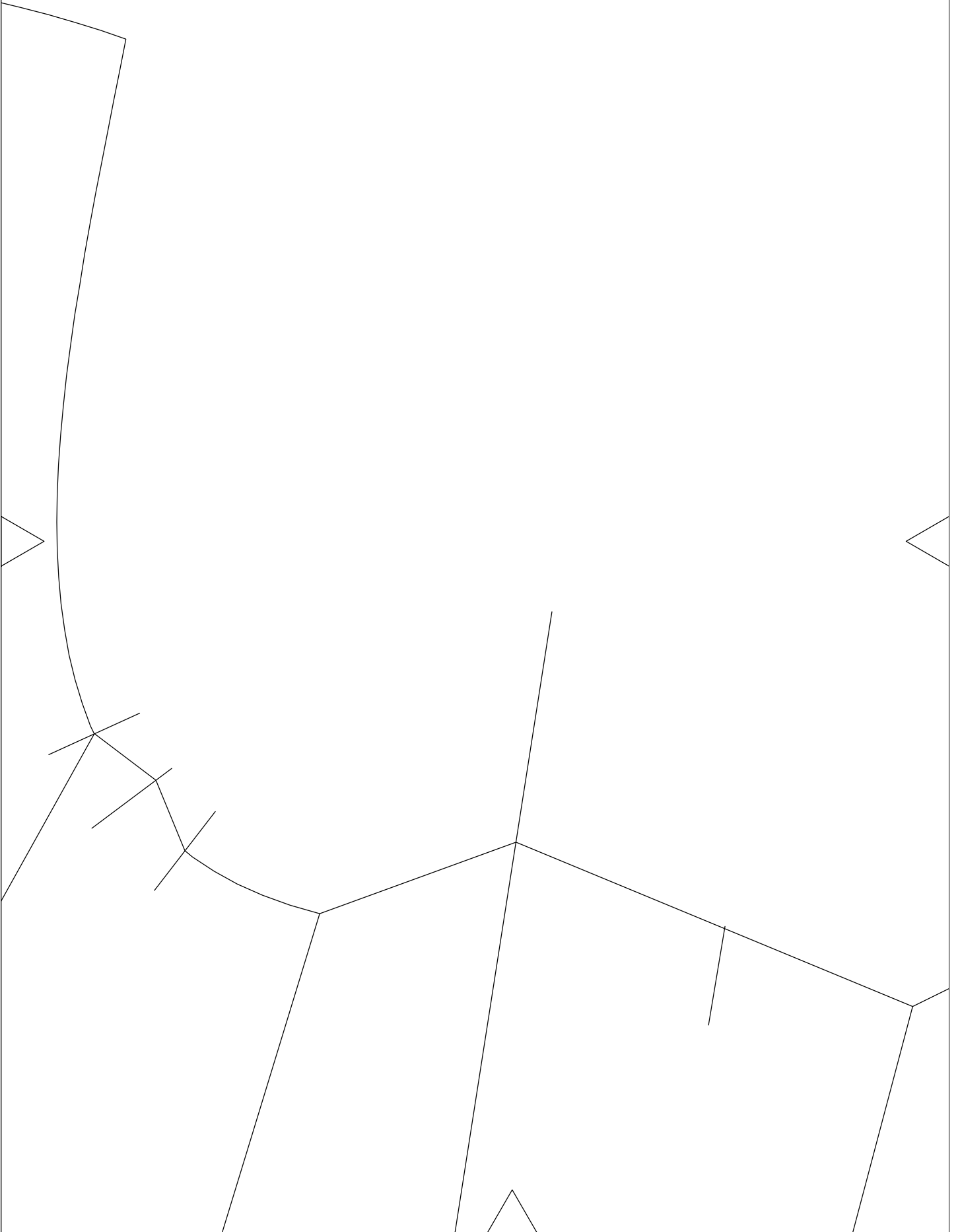

5

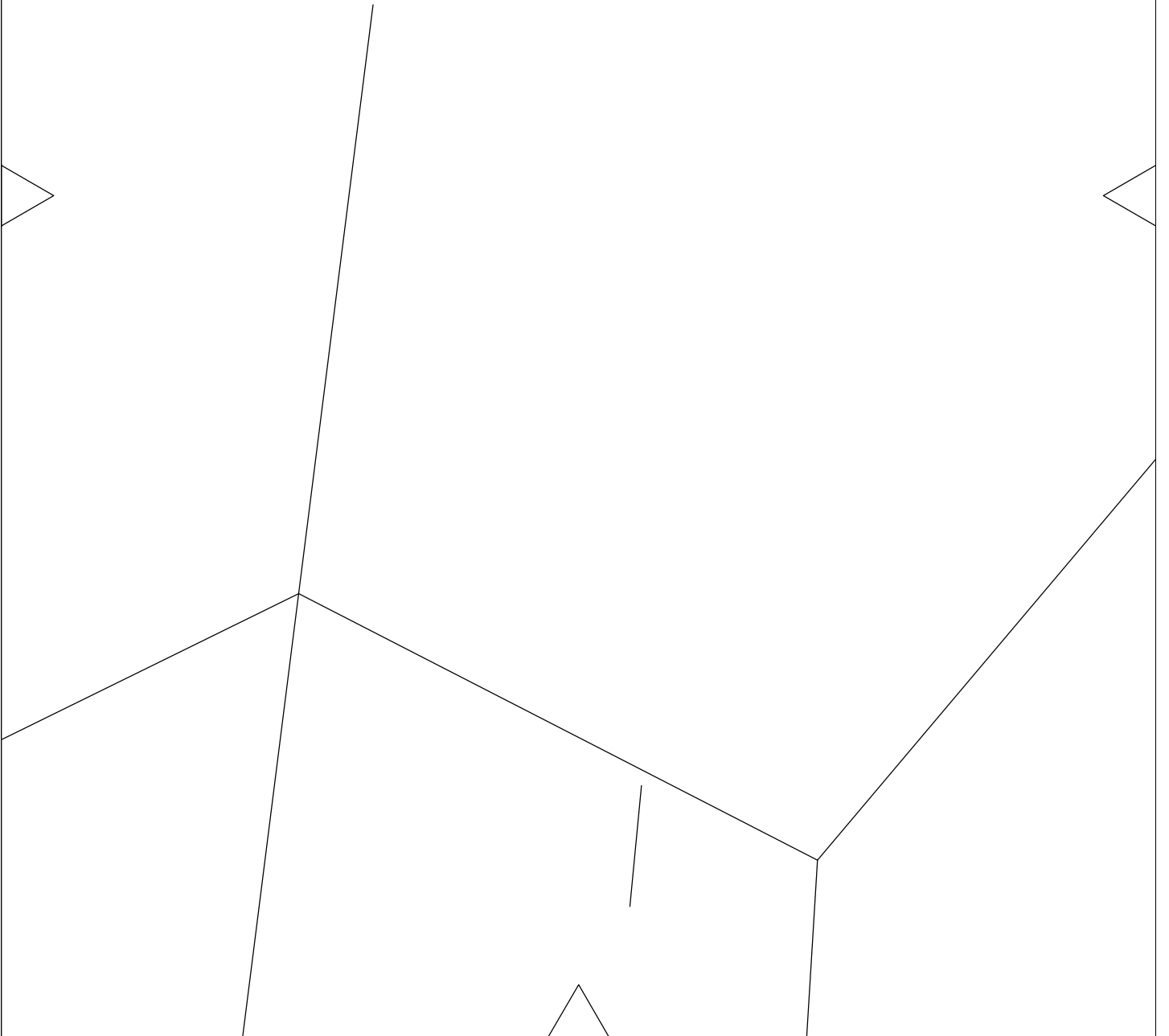

6

*Levý rukáv*



The image shows a technical drawing of a left sleeve pattern piece. The pattern is a trapezoidal shape with a curved top edge and a curved bottom edge. The text "Levý rukáv" is written in a bold, italicized font across the center of the pattern. There are three small triangles pointing outwards from the pattern: one on the left side, one on the right side, and one at the bottom center. A small vertical line is drawn near the top left corner of the pattern.

7

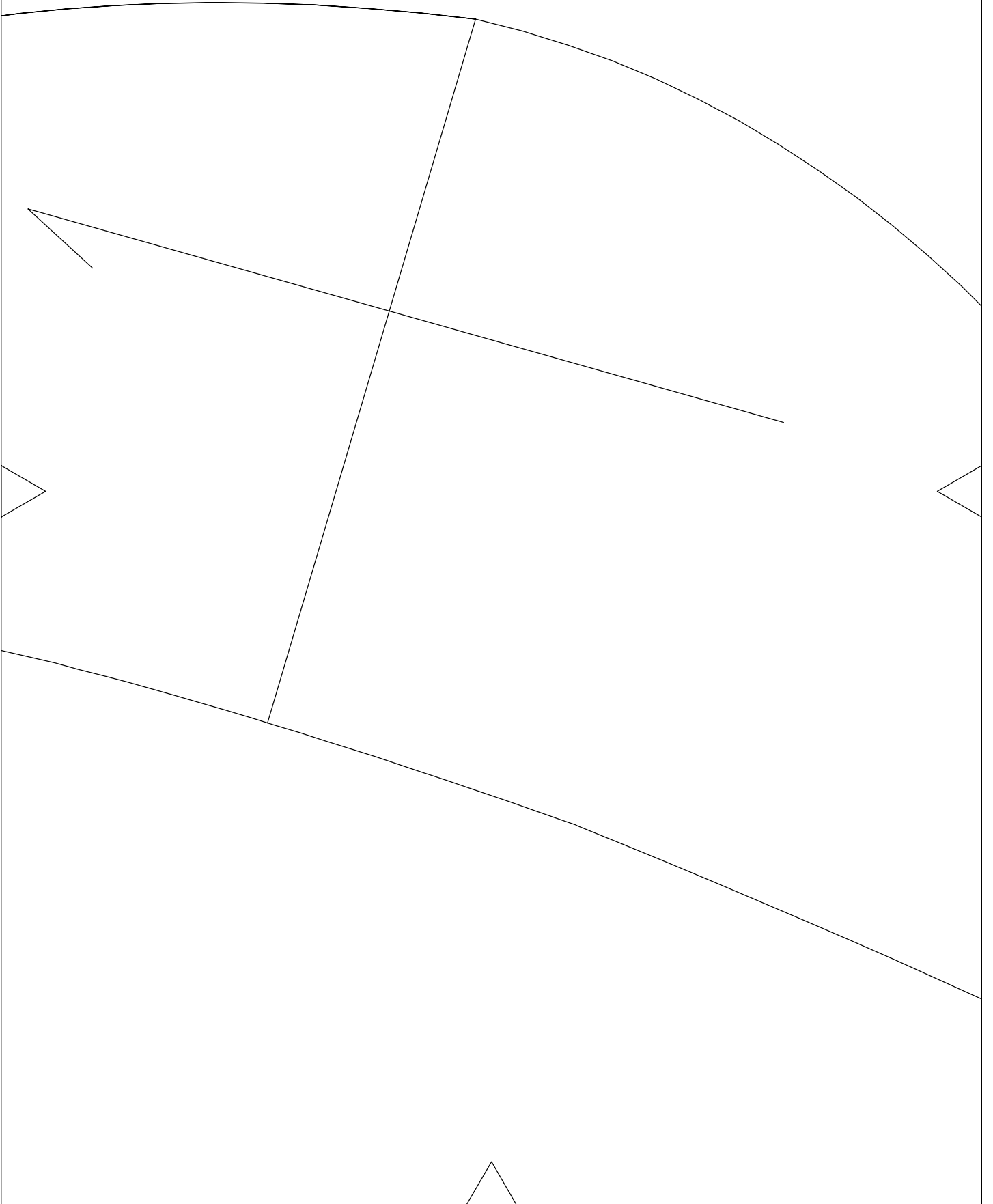





9



10

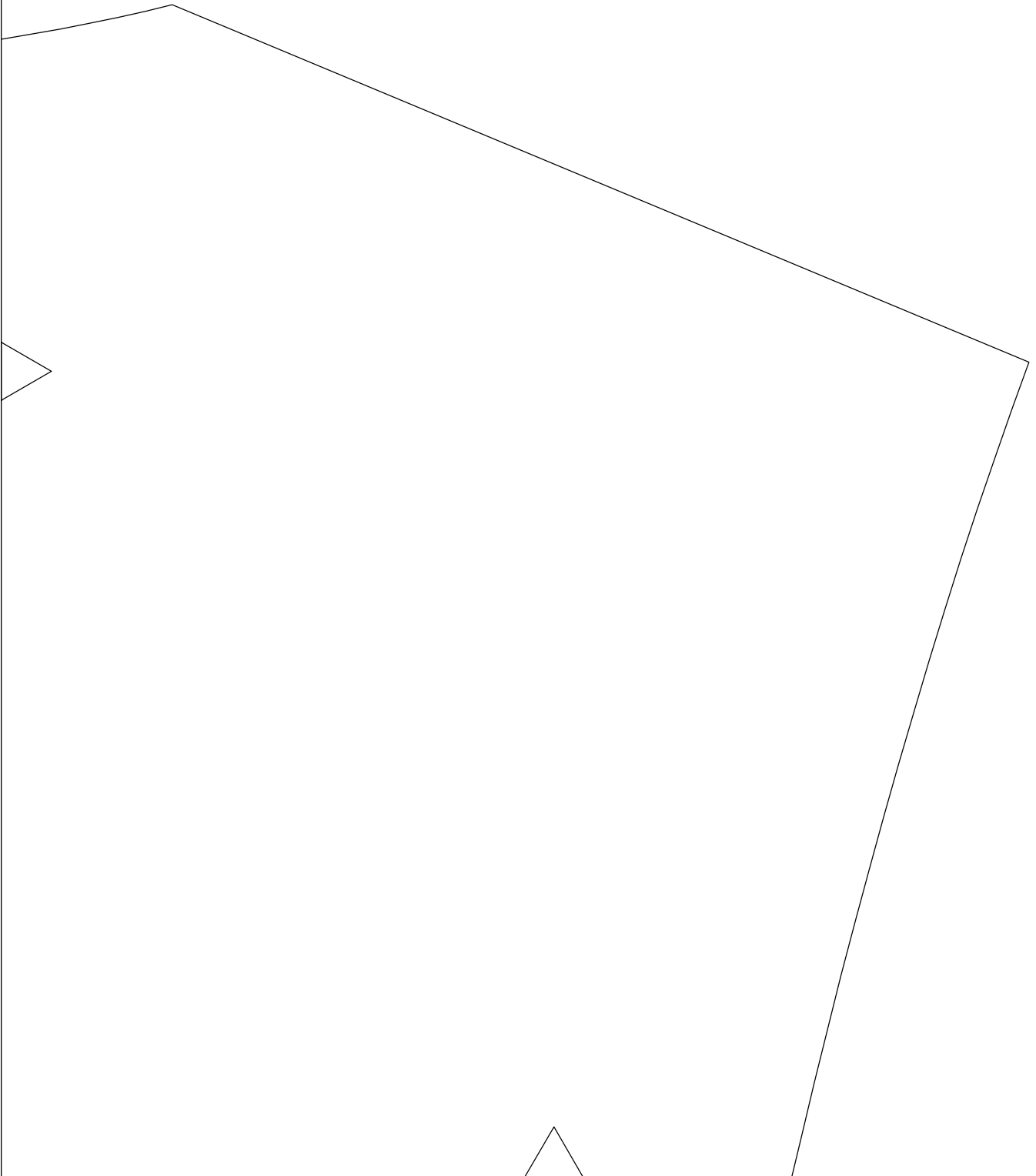

11



12

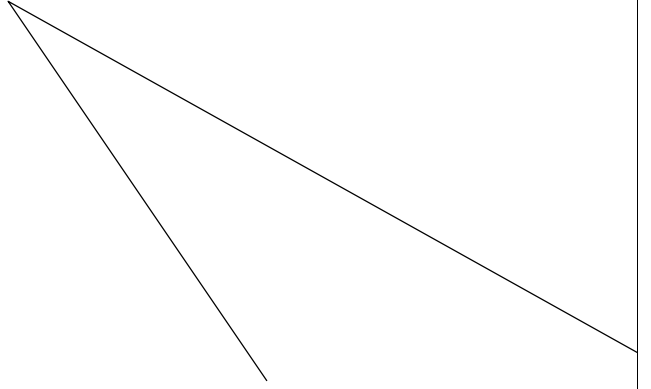

13

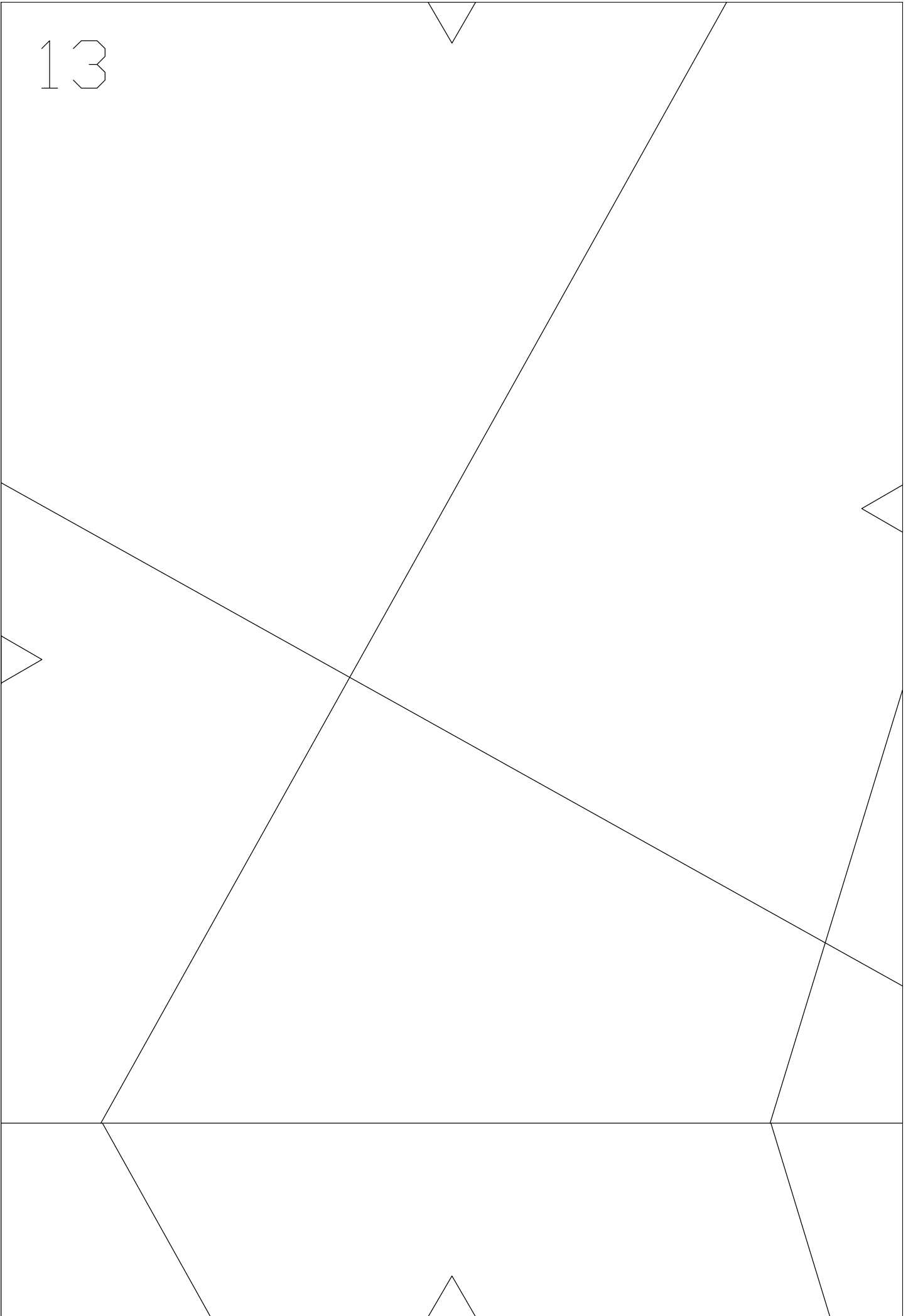

14

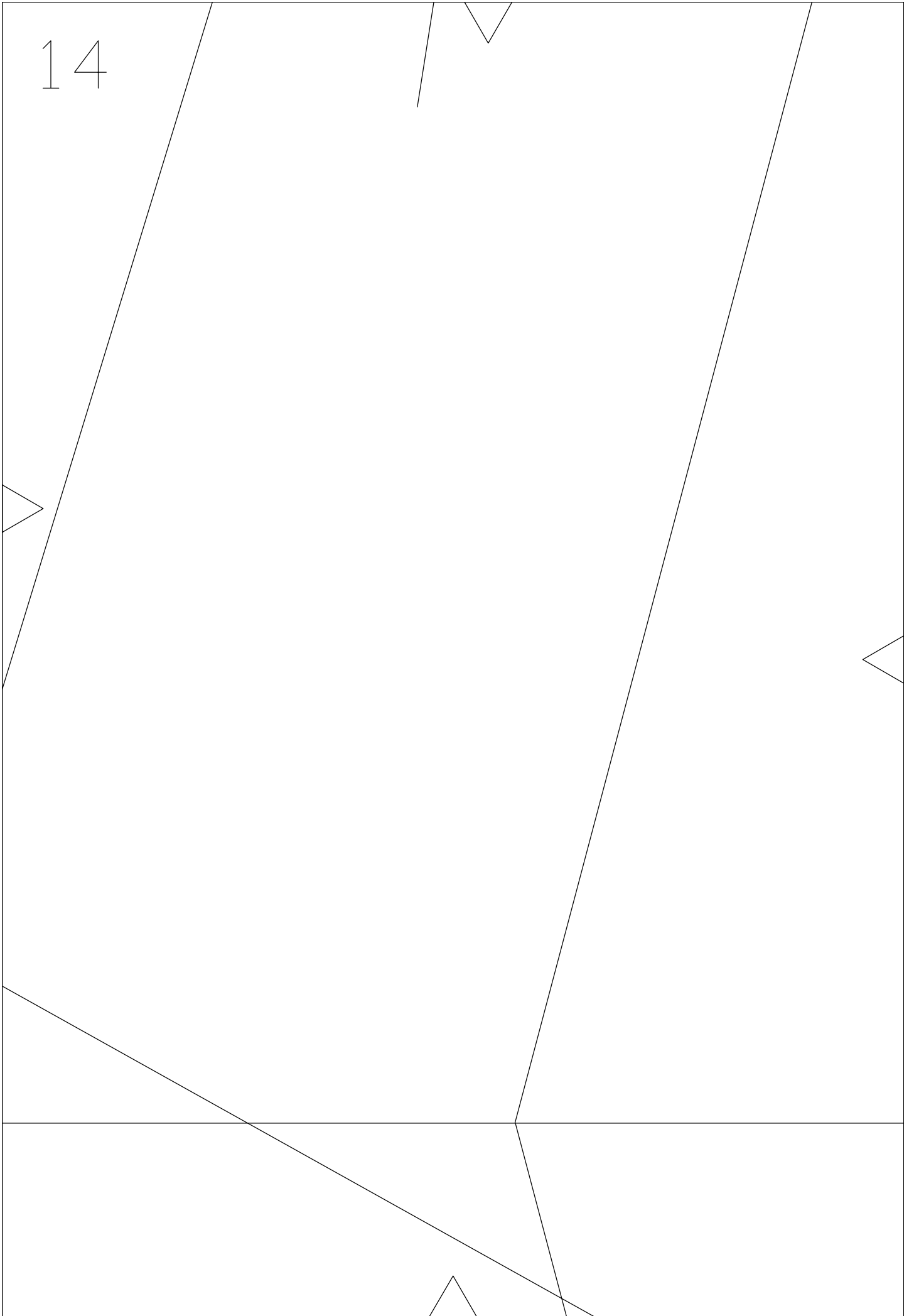

15

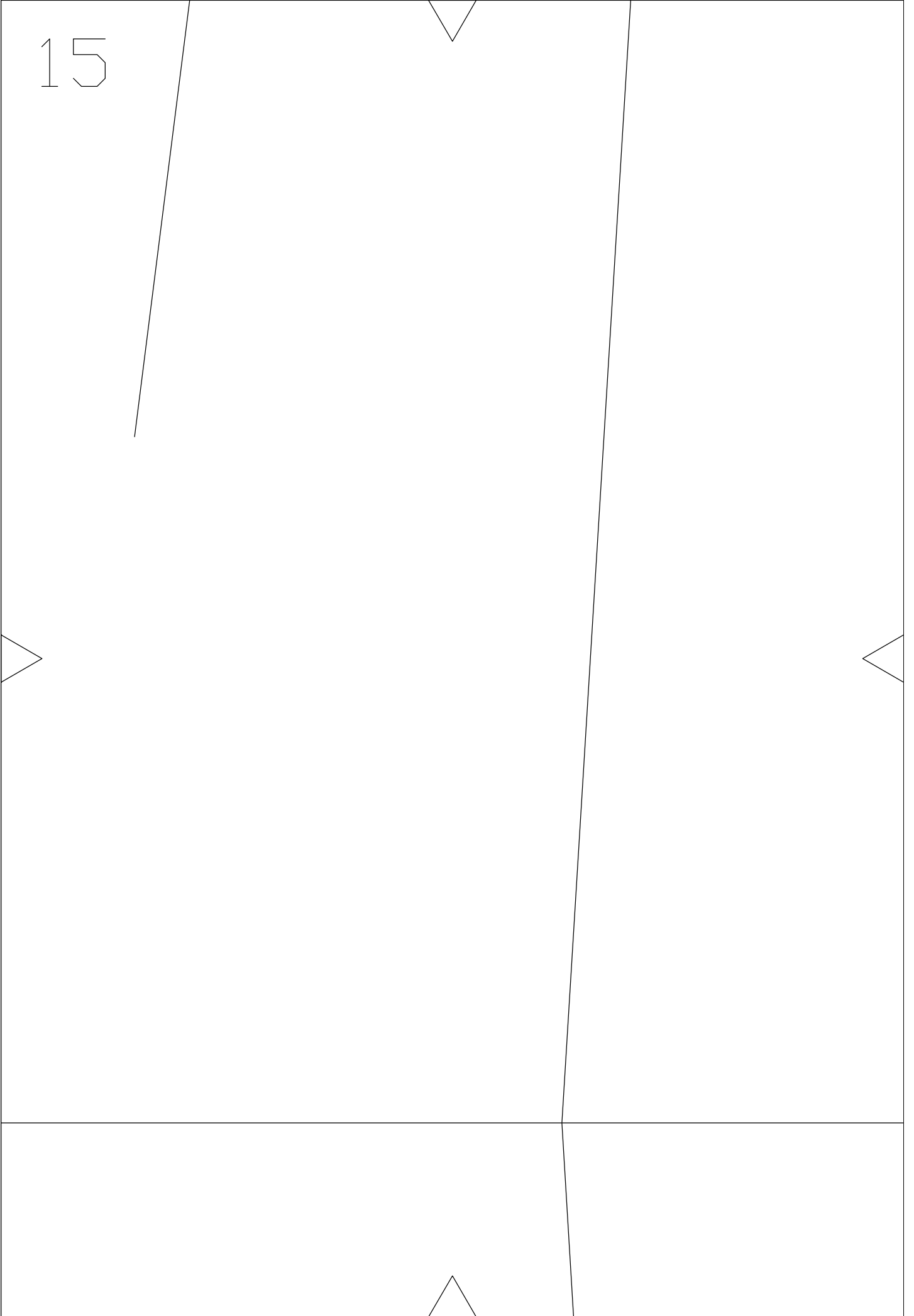



16

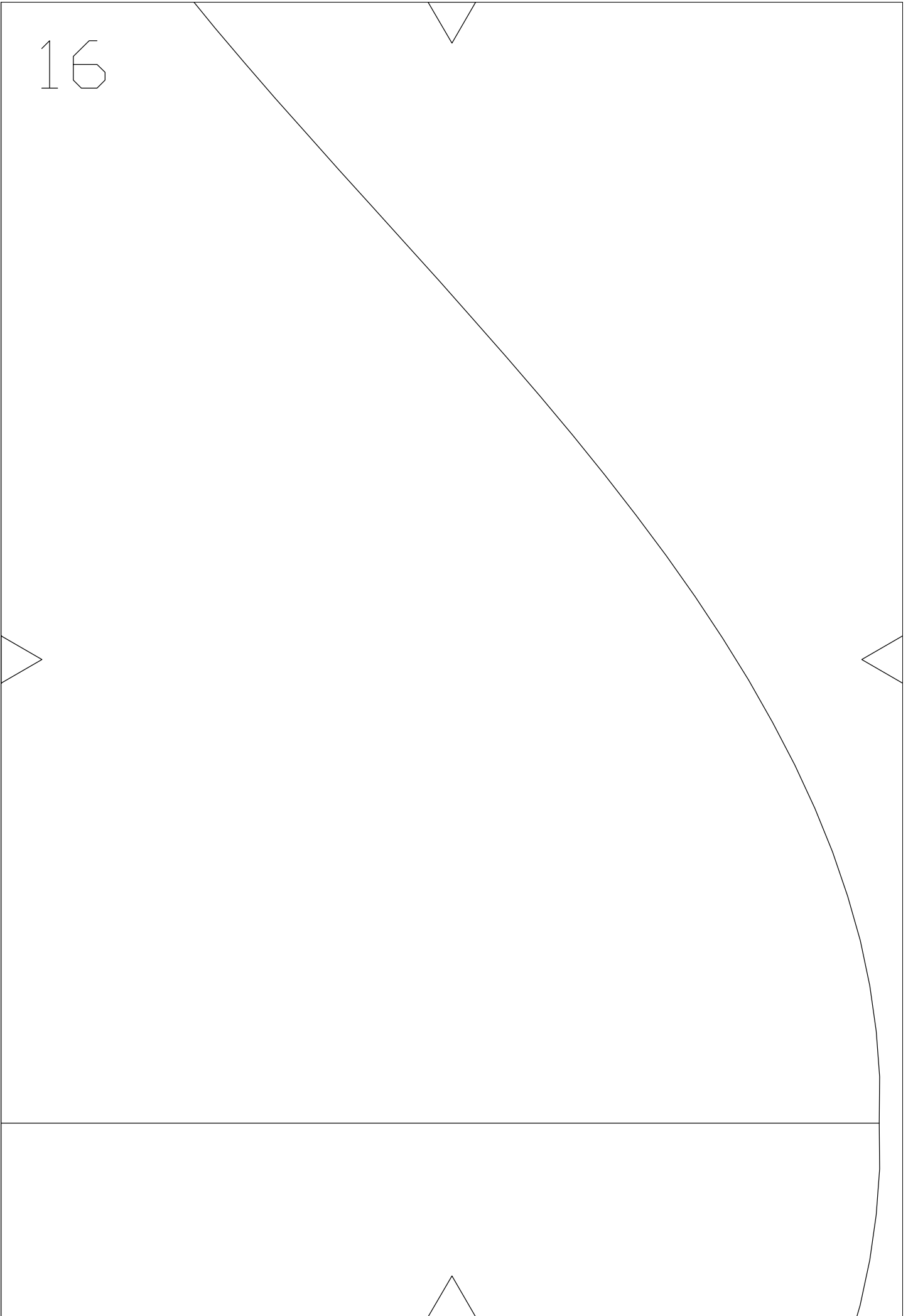

17



18

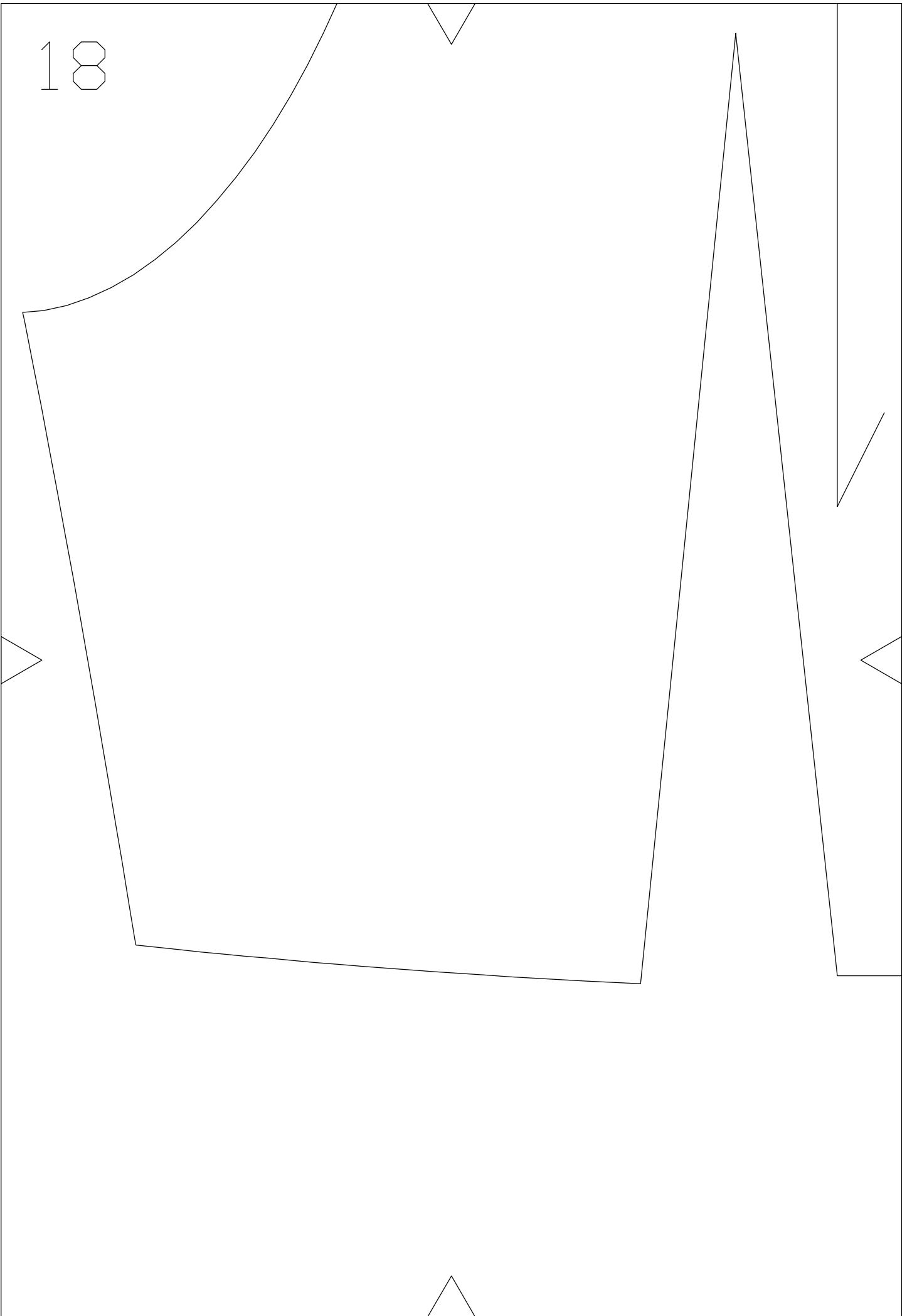

# Zadní díl živůtku

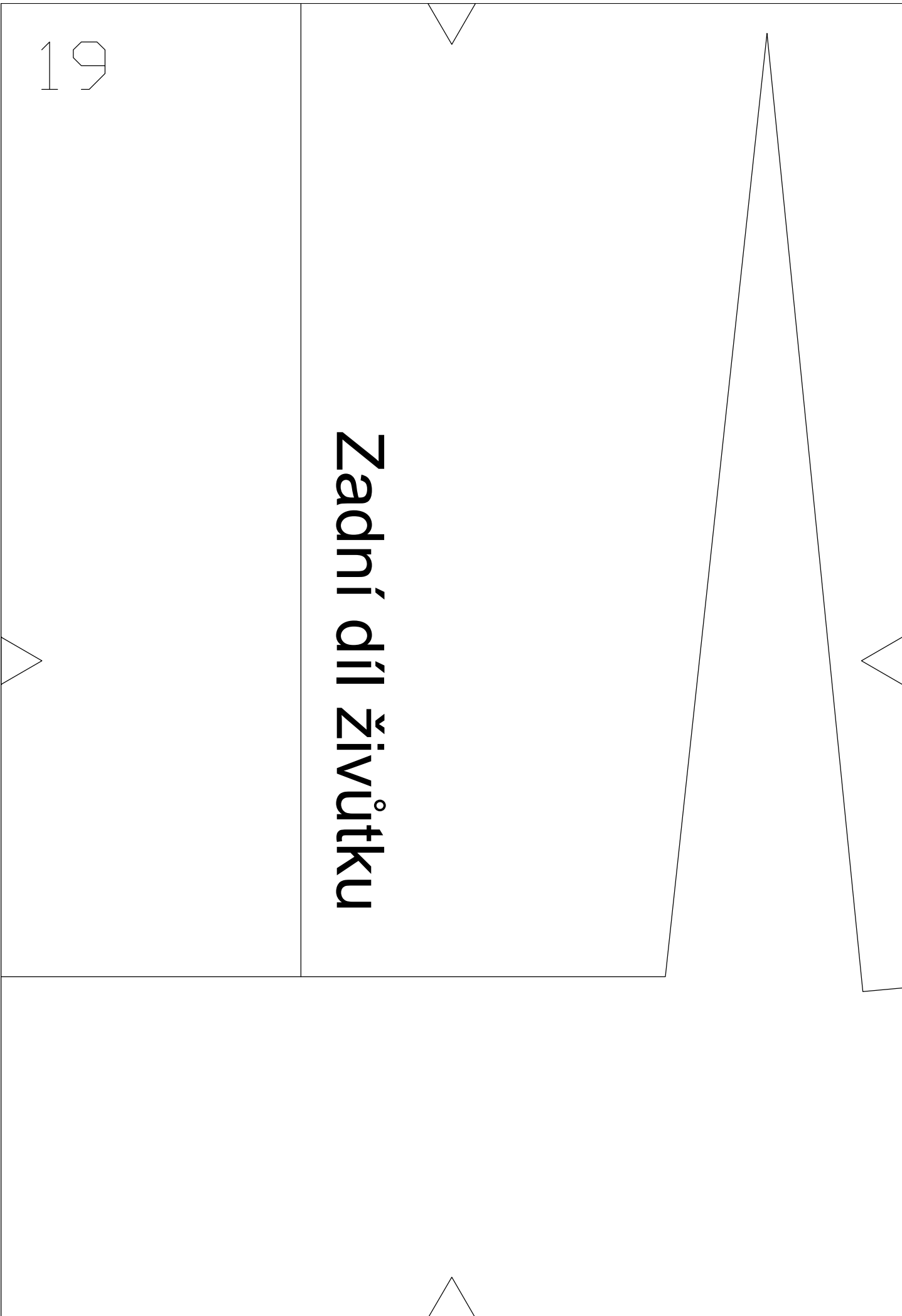

20

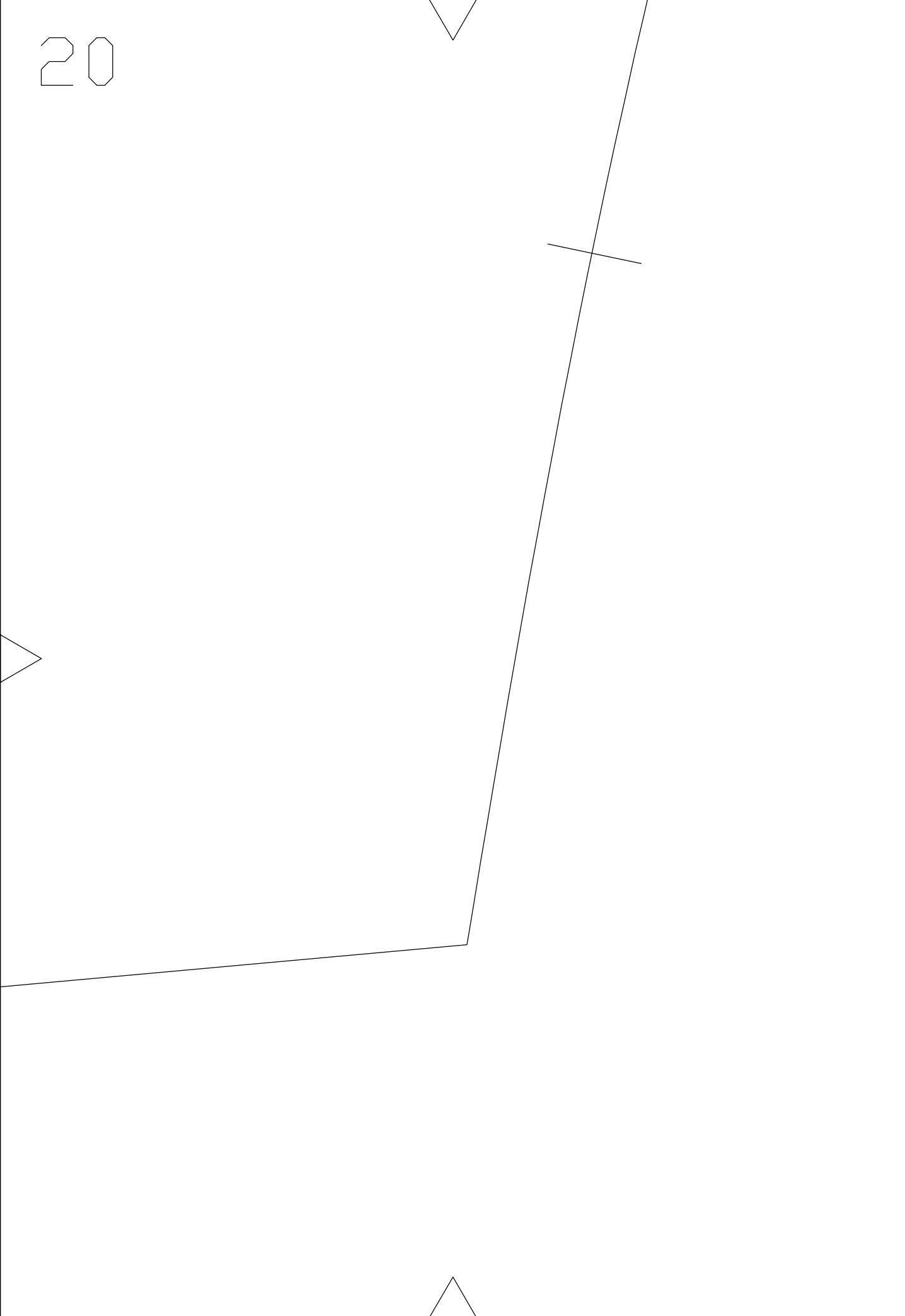

21

**Sukně**

22



23

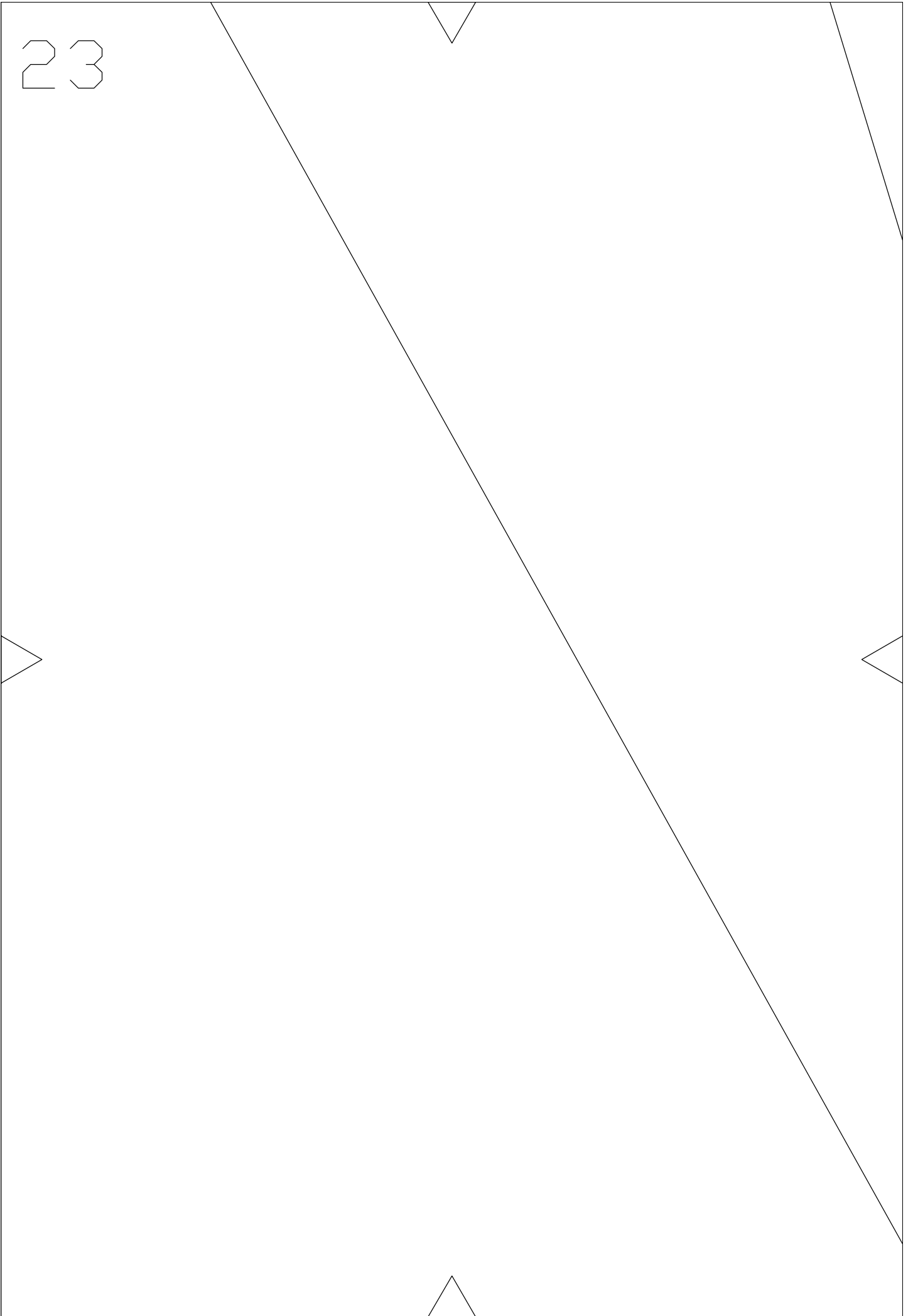





25

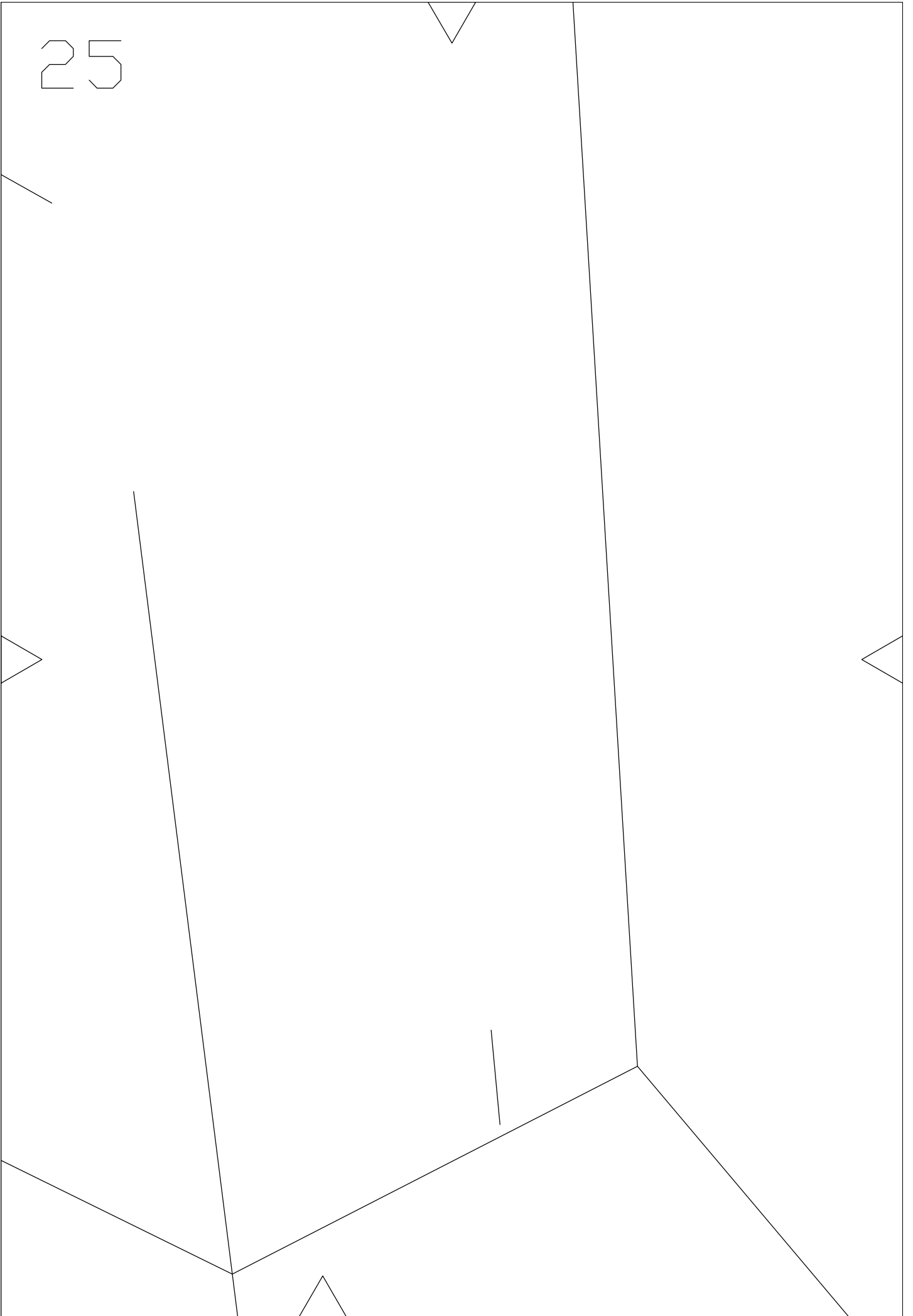

26

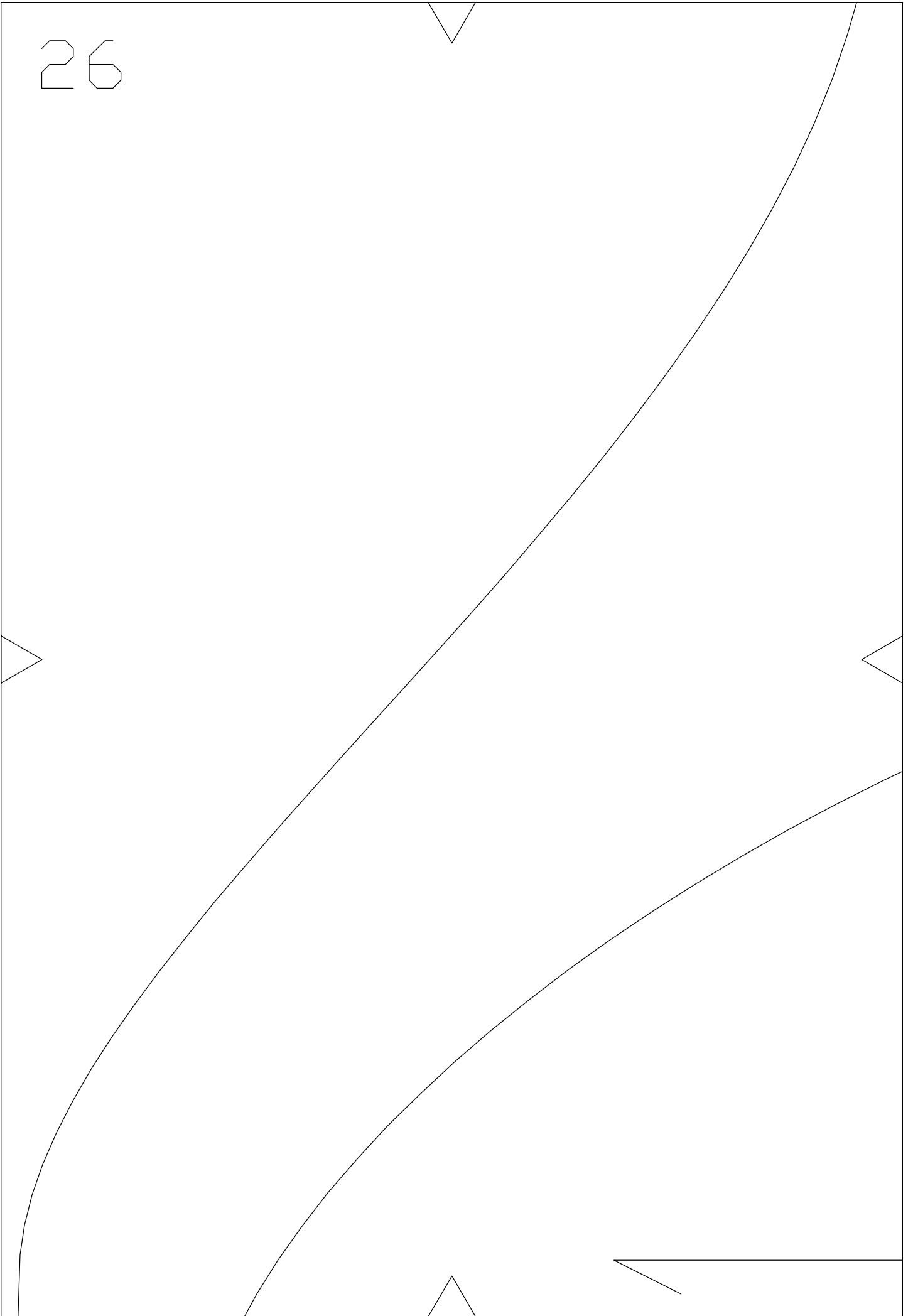

27

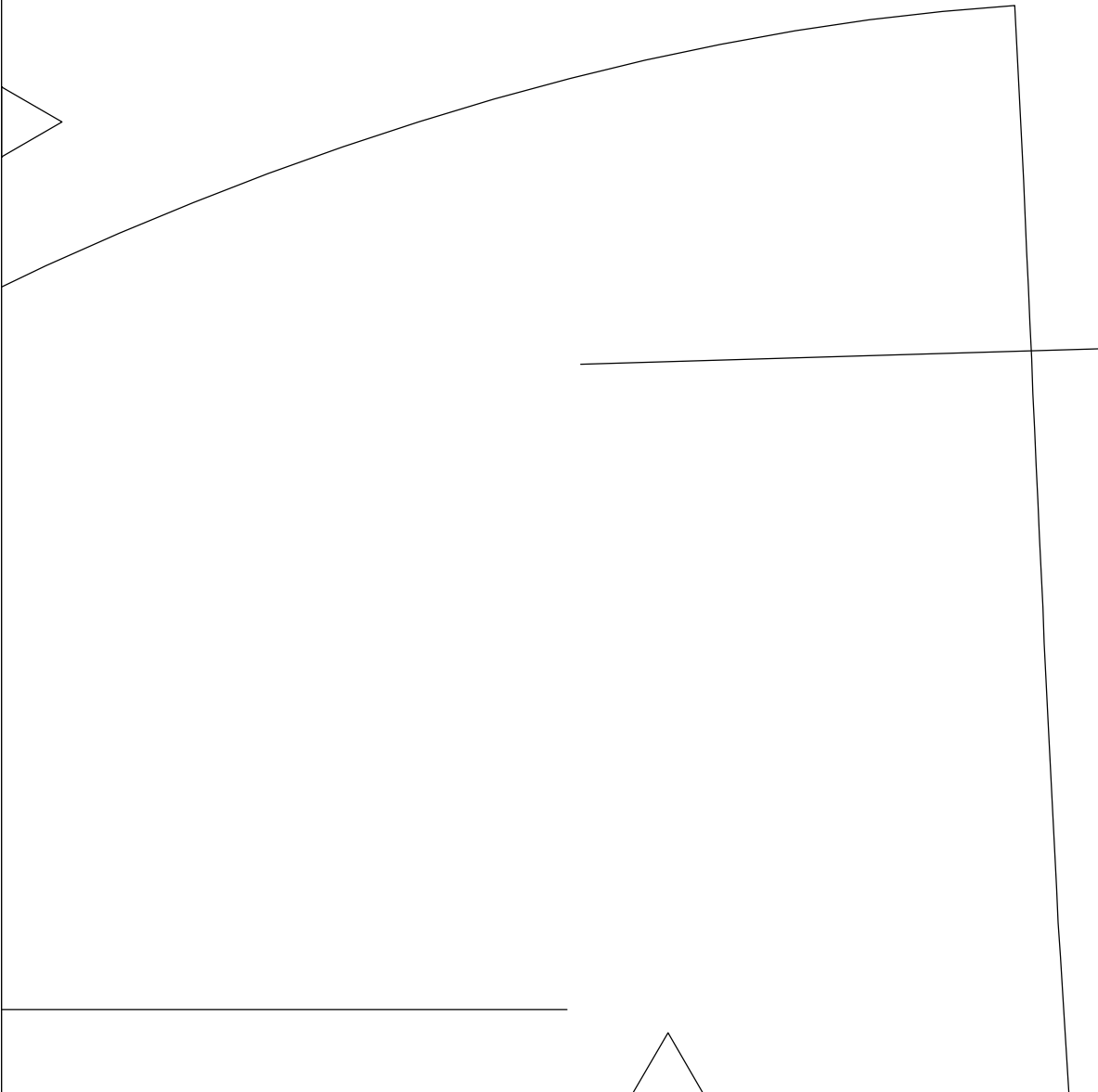

28

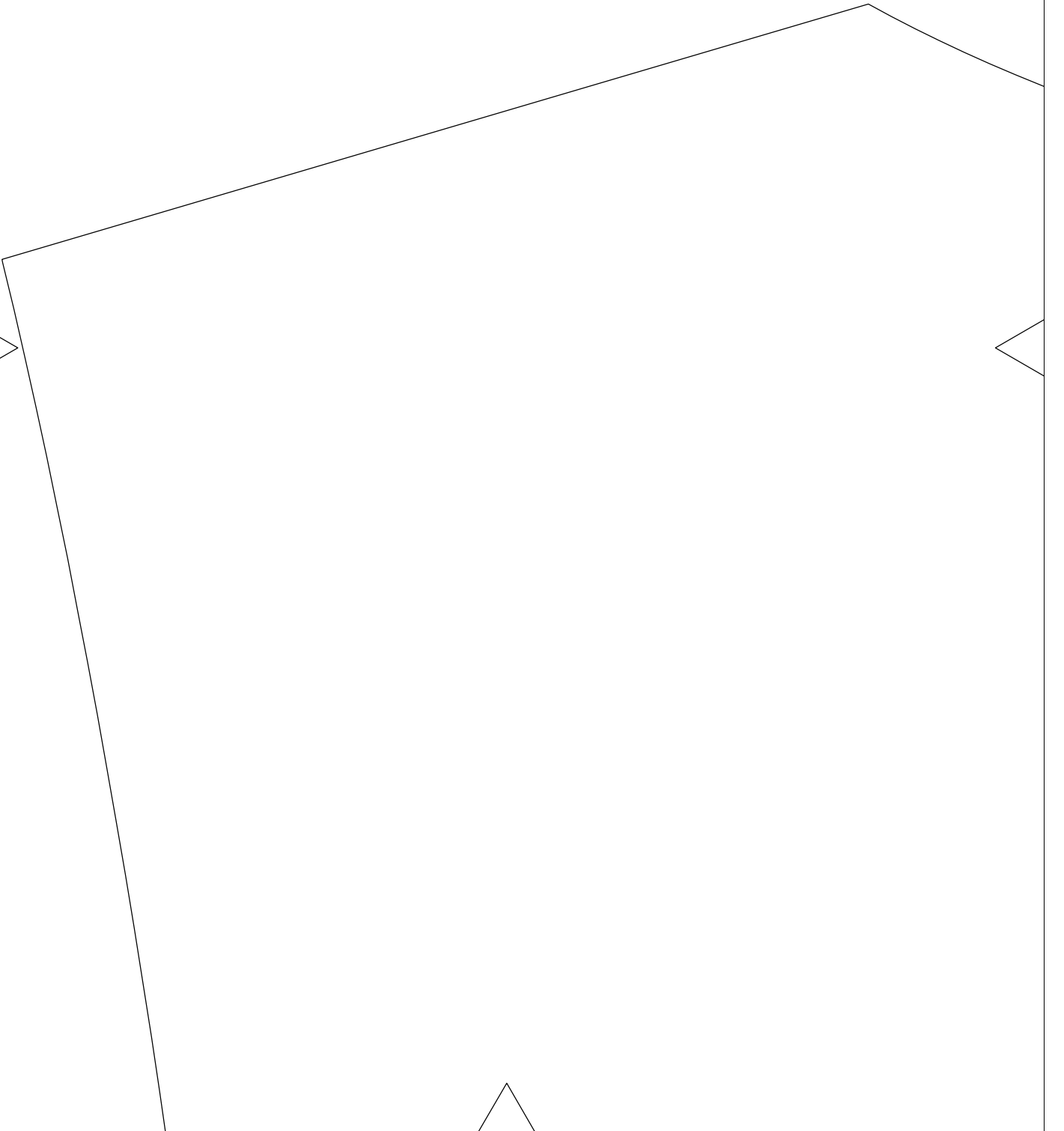

# Přední díl živůtku



30

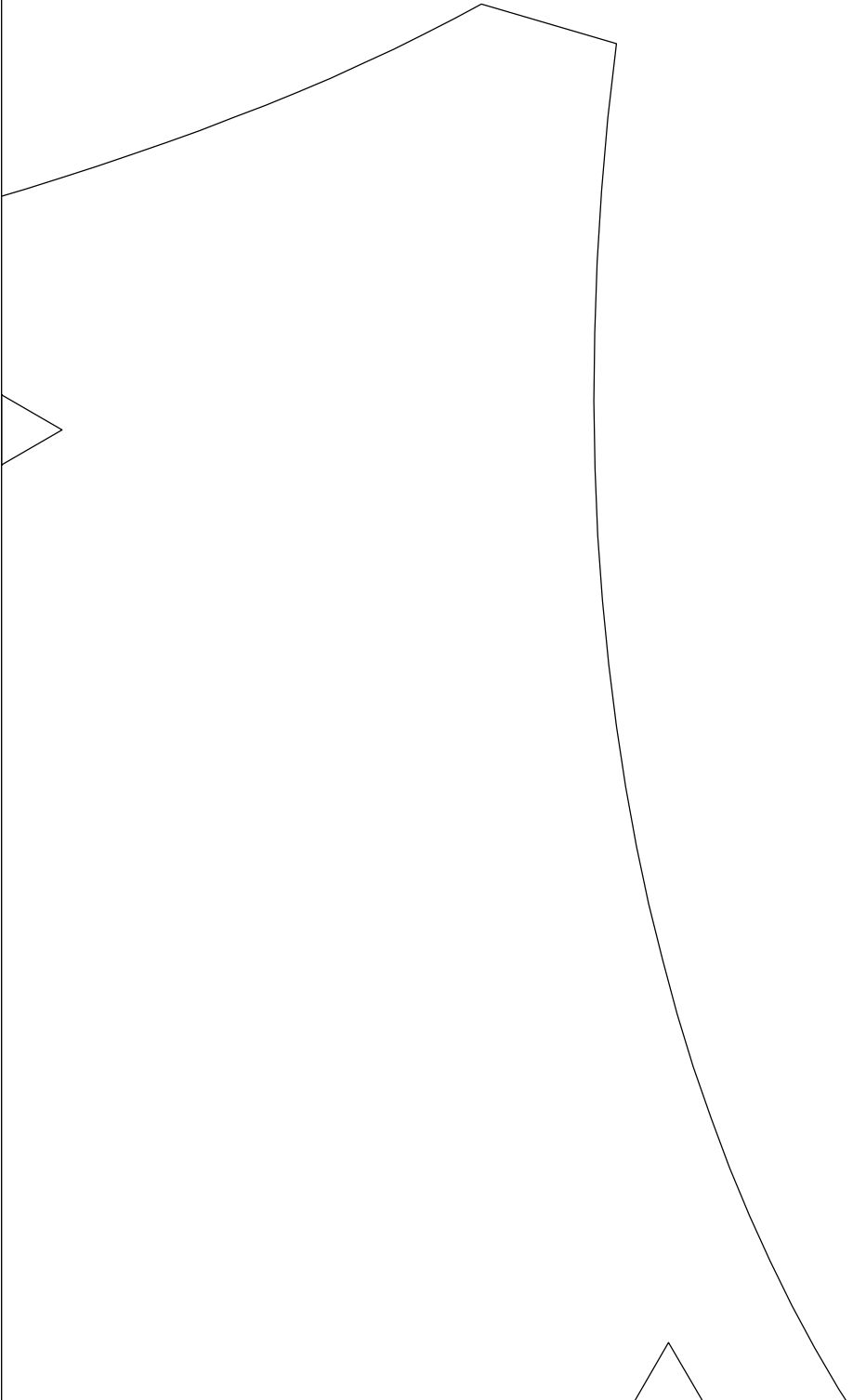

31





32



33



34

**KONTROLNÍ  
ČTVEREČEK  
10 x 10 CM**

35

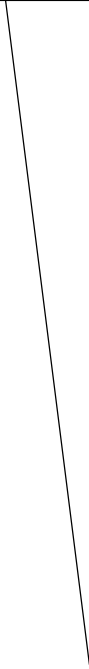

36

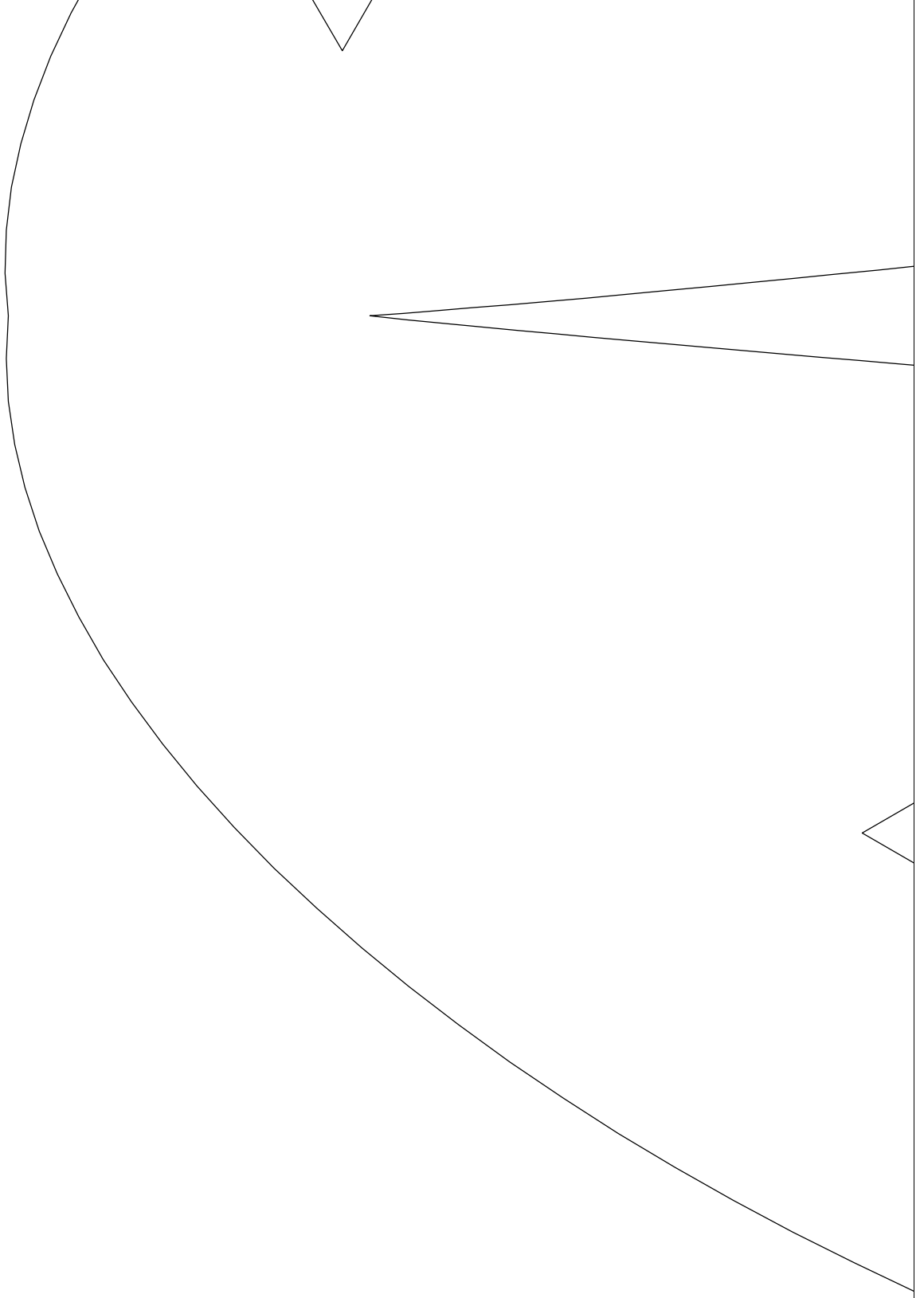

37

# Pravá kapsa



38

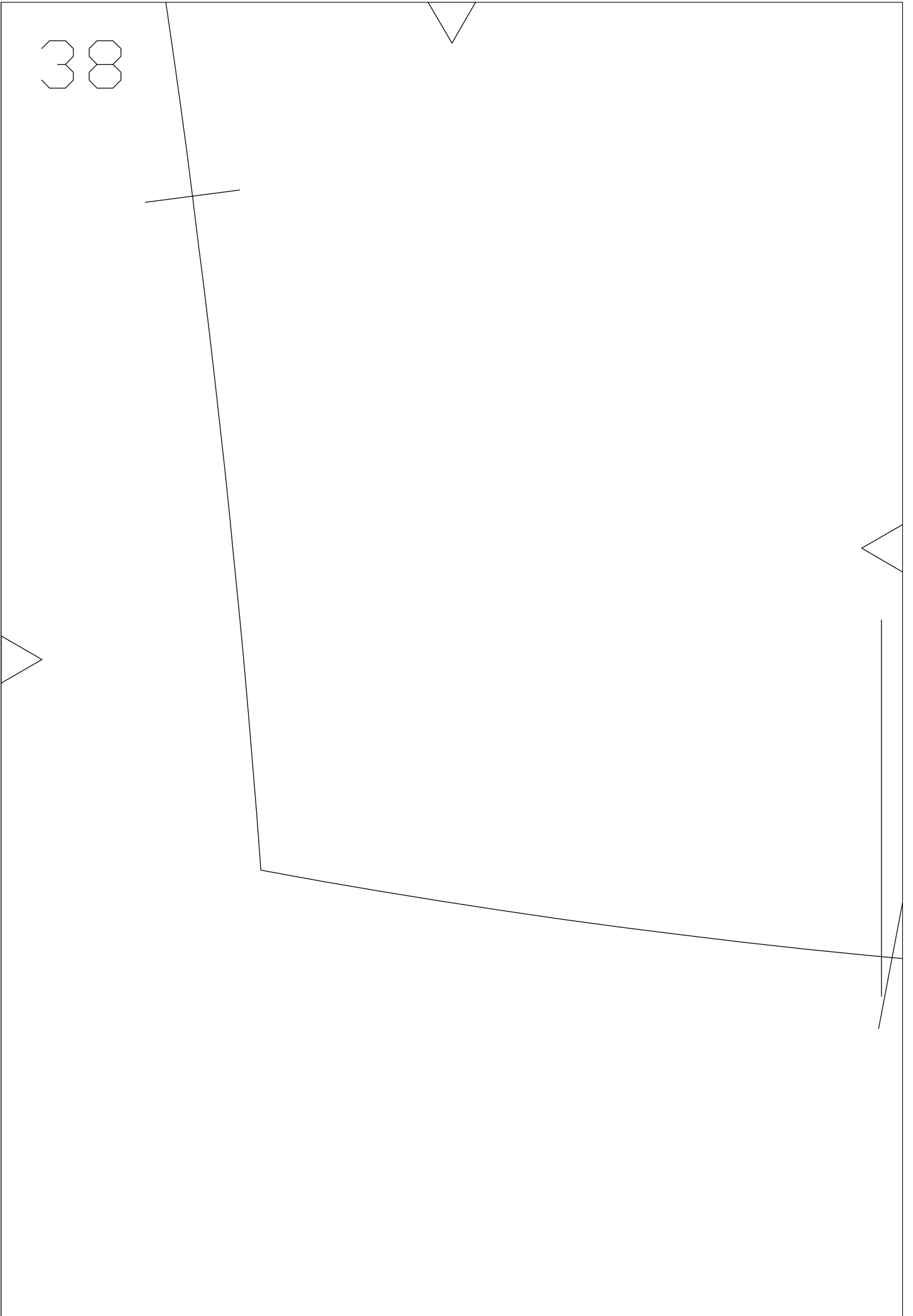

39

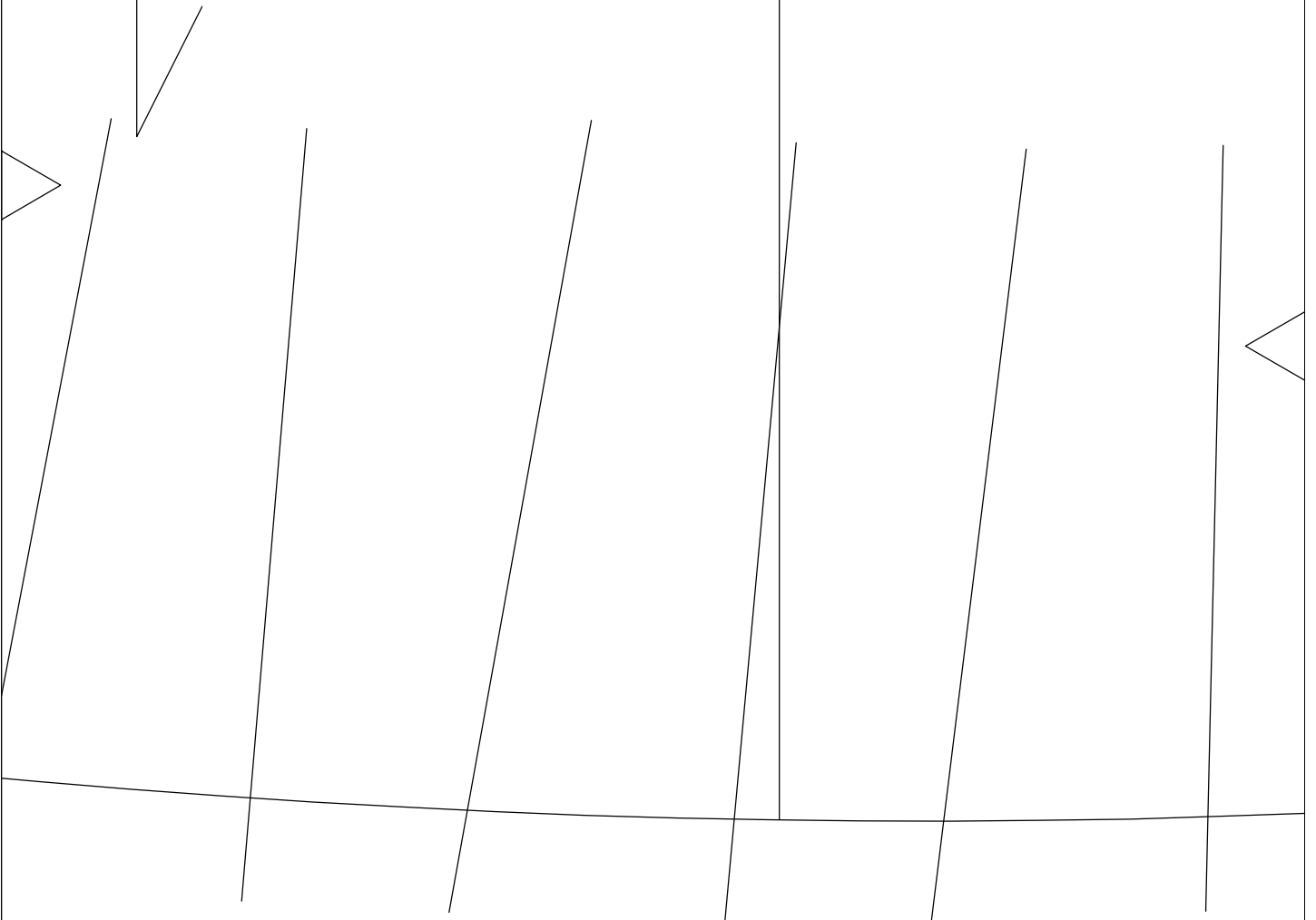



40

